

MATERIAL	Brass Glass
HEIGHT	25cm 9.84"
WIDTH DIAMETER	40cm 15.75"
LENGTH PROJECTION	n/a
WEIGHT	3.12KG 6.88lbs
LAMP HOLDER	E27 or E26 *
MAX WATTAGE	6.5W x 1
VOLTAGE	220/240v or 110/120v *
IP RATING	65
CLASS PROTECTION	II
SHADE CODE	GL089 GLWP01
CABLE CHAIN BAR LENGT	n/a
CABLE TYPE	-

Fixing Bracket MLWB17 | Antique Brass

* Fixing bracket may differ for UL wired products.

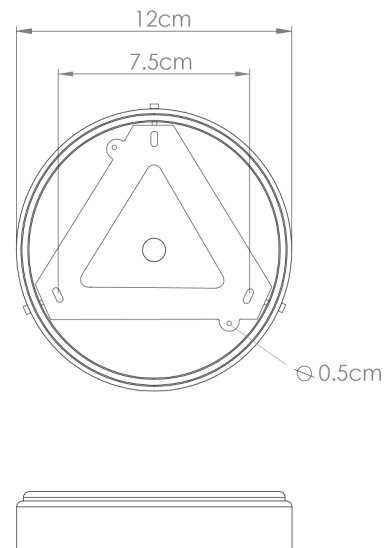

Product Notes:

1) Bulbs not included. 2) Dimensions do not include bulbs. 3) All products are individually made-to-order and therefore may differ slightly within manufacturing tolerances. 4) Cable / chain can be shortened during installation. Longer cable / chain lengths available on request. 5) Additional colour finishes may be available on request. 6) UL wired products operate at 110/120v with the appropriate lamp holder. 7) Twisted cable is not available for UL wired products. Round cable in black or brown only is supplied instead. 8) Refer to our website for a full list of terms and conditions.

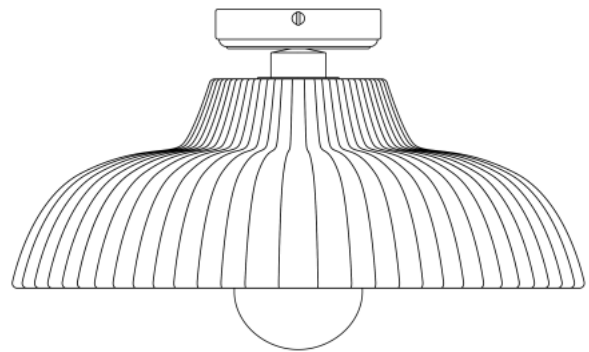

MATERIAL	Brass Glass
HEIGHT	25cm 9.84"
WIDTH DIAMETER	40cm 15.75"
LENGTH PROJECTION	n/a
WEIGHT	3.12KG 6.88lbs
LAMP HOLDER	E27 or E26 *
MAX WATTAGE	6.5W x 1
VOLTAGE	220/240v or 110/120v *
IP RATING	65
CLASS PROTECTION	II
SHADE CODE	GL089 GLWP02
CABLE CHAIN BAR LENGT	n/a
CABLE TYPE	-

Fixing Bracket MLWB17 | Antique Brass
 * Fixing bracket may differ for UL wired products.

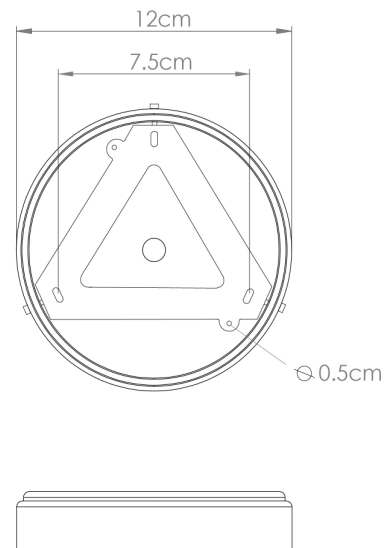

Product Notes:

1) Bulbs not included. 2) Dimensions do not include bulbs. 3) All products are individually made-to-order and therefore may differ slightly within manufacturing tolerances. 4) Cable / chain can be shortened during installation. Longer cable / chain lengths available on request. 5) Additional colour finishes may be available on request. 6) UL wired products operate at 110/120v with the appropriate lamp holder. 7) Twisted cable is not available for UL wired products. Round cable in black or brown only is supplied instead. 8) Refer to our website for a full list of terms and conditions.

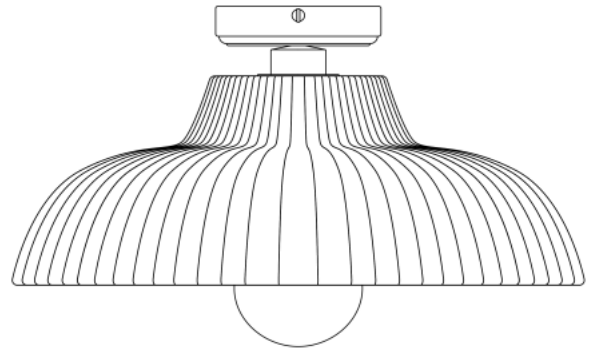

MATERIAL	Brass Glass
HEIGHT	25cm 9.84"
WIDTH DIAMETER	40cm 15.75"
LENGTH PROJECTION	n/a
WEIGHT	3.12KG 6.88lbs
LAMP HOLDER	E27 or E26 *
MAX WATTAGE	6.5W x 1
VOLTAGE	220/240v or 110/120v *
IP RATING	65
CLASS PROTECTION	II
SHADE CODE	GL089 GLWP01
CABLE CHAIN BAR LENGT	n/a
CABLE TYPE	-

Fixing Bracket MLWB17 | Antique Silver
 * Fixing bracket may differ for UL wired products.

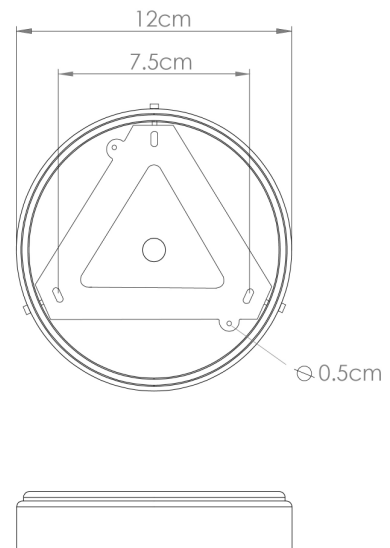

Product Notes:

1) Bulbs not included. 2) Dimensions do not include bulbs. 3) All products are individually made-to-order and therefore may differ slightly within manufacturing tolerances. 4) Cable / chain can be shortened during installation. Longer cable / chain lengths available on request. 5) Additional colour finishes may be available on request. 6) UL wired products operate at 110/120v with the appropriate lamp holder. 7) Twisted cable is not available for UL wired products. Round cable in black or brown only is supplied instead. 8) Refer to our website for a full list of terms and conditions.

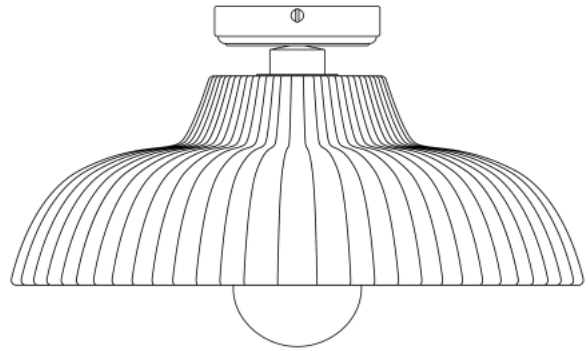

MATERIAL	Brass Glass
HEIGHT	25cm 9.84"
WIDTH DIAMETER	40cm 15.75"
LENGTH PROJECTION	n/a
WEIGHT	3.12KG 6.88lbs
LAMP HOLDER	E27 or E26 *
MAX WATTAGE	6.5W x 1
VOLTAGE	220/240v or 110/120v *
IP RATING	65
CLASS PROTECTION	II
SHADE CODE	GL089 GLWP02
CABLE CHAIN BAR LENGT	n/a
CABLE TYPE	-

Fixing Bracket MLWB17 | Antique Silver
 * Fixing bracket may differ for UL wired products.

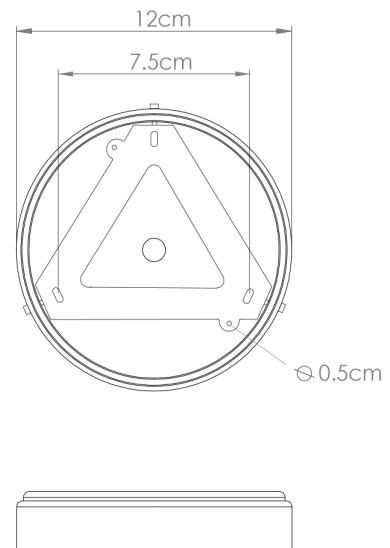

Product Notes:

1) Bulbs not included. 2) Dimensions do not include bulbs. 3) All products are individually made-to-order and therefore may differ slightly within manufacturing tolerances. 4) Cable / chain can be shortened during installation. Longer cable / chain lengths available on request. 5) Additional colour finishes may be available on request. 6) UL wired products operate at 110/120v with the appropriate lamp holder. 7) Twisted cable is not available for UL wired products. Round cable in black or brown only is supplied instead. 8) Refer to our website for a full list of terms and conditions.

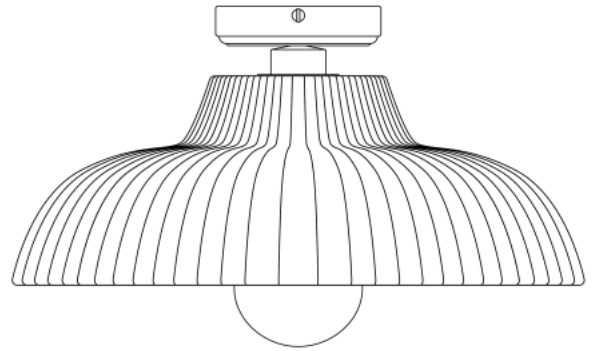

MATERIAL	Brass Glass
HEIGHT	25cm 9.84"
WIDTH DIAMETER	40cm 15.75"
LENGTH PROJECTION	n/a
WEIGHT	3.12KG 6.88lbs
LAMP HOLDER	E27 or E26 *
MAX WATTAGE	6.5W x 1
VOLTAGE	220/240v or 110/120v *
IP RATING	65
CLASS PROTECTION	II
SHADE CODE	GL089 GLWP01
CABLE CHAIN BAR LENGT	n/a
CABLE TYPE	-

Fixing Bracket MLWB17 | Natural Brass

* Fixing bracket may differ for UL wired products.

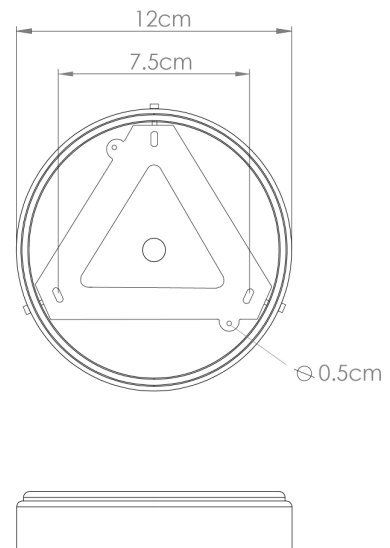

Product Notes:

1) Bulbs not included. 2) Dimensions do not include bulbs. 3) All products are individually made-to-order and therefore may differ slightly within manufacturing tolerances. 4) Cable / chain can be shortened during installation. Longer cable / chain lengths available on request. 5) Additional colour finishes may be available on request. 6) UL wired products operate at 110/120v with the appropriate lamp holder. 7) Twisted cable is not available for UL wired products. Round cable in black or brown only is supplied instead. 8) Refer to our website for a full list of terms and conditions.

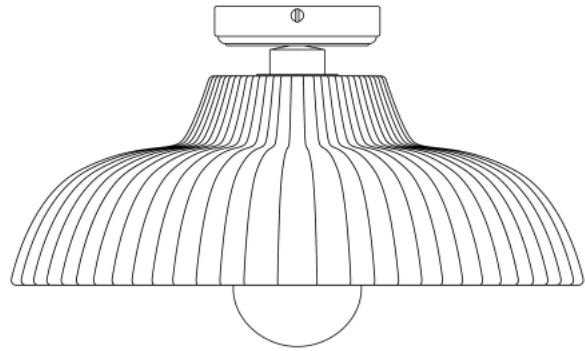

MATERIAL	Brass Glass
HEIGHT	25cm 9.84"
WIDTH DIAMETER	40cm 15.75"
LENGTH PROJECTION	n/a
WEIGHT	3.12KG 6.88lbs
LAMP HOLDER	E27 or E26 *
MAX WATTAGE	6.5W x 1
VOLTAGE	220/240v or 110/120v *
IP RATING	65
CLASS PROTECTION	II
SHADE CODE	GL089 GLWP02
CABLE CHAIN BAR LENGT	n/a
CABLE TYPE	-

Fixing Bracket MLWB17 | Natural Brass

* Fixing bracket may differ for UL wired products.

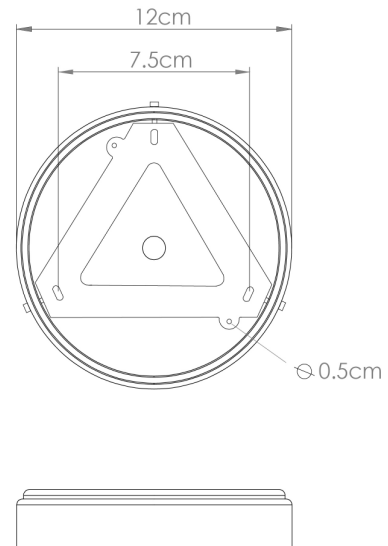

Product Notes:

1) Bulbs not included. 2) Dimensions do not include bulbs. 3) All products are individually made-to-order and therefore may differ slightly within manufacturing tolerances. 4) Cable / chain can be shortened during installation. Longer cable / chain lengths available on request. 5) Additional colour finishes may be available on request. 6) UL wired products operate at 110/120v with the appropriate lamp holder. 7) Twisted cable is not available for UL wired products. Round cable in black or brown only is supplied instead. 8) Refer to our website for a full list of terms and conditions.

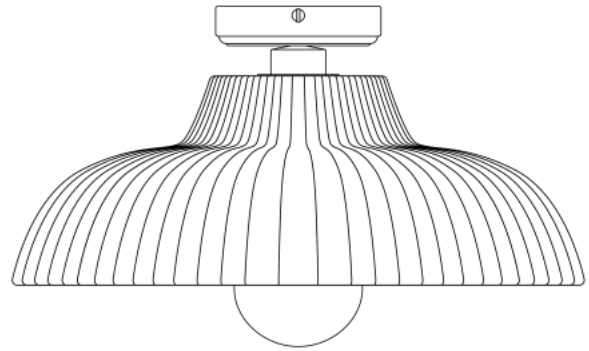

MATERIAL	Brass Glass
HEIGHT	25cm 9.84"
WIDTH DIAMETER	40cm 15.75"
LENGTH PROJECTION	n/a
WEIGHT	3.12KG 6.88lbs
LAMP HOLDER	E27 or E26 *
MAX WATTAGE	6.5W x 1
VOLTAGE	220/240v or 110/120v *
IP RATING	65
CLASS PROTECTION	II
SHADE CODE	GL089 GLWP01
CABLE CHAIN BAR LENGT	n/a
CABLE TYPE	-

Fixing Bracket MLWB17 | Matt Black

* Fixing bracket may differ for UL wired products.

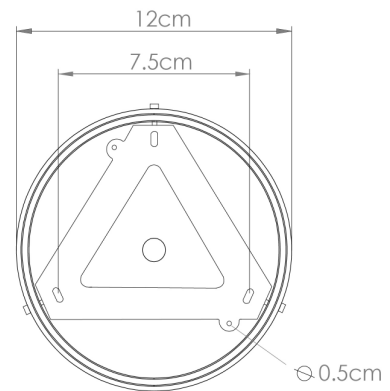

Product Notes:

1) Bulbs not included. 2) Dimensions do not include bulbs. 3) All products are individually made-to-order and therefore may differ slightly within manufacturing tolerances. 4) Cable / chain can be shortened during installation. Longer cable / chain lengths available on request. 5) Additional colour finishes may be available on request. 6) UL wired products operate at 110/120v with the appropriate lamp holder. 7) Twisted cable is not available for UL wired products. Round cable in black or brown only is supplied instead. 8) Refer to our website for a full list of terms and conditions.

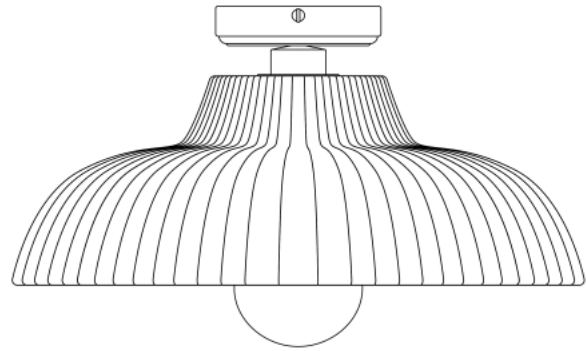

MATERIAL	Brass Glass
HEIGHT	25cm 9.84"
WIDTH DIAMETER	40cm 15.75"
LENGTH PROJECTION	n/a
WEIGHT	3.12KG 6.88lbs
LAMP HOLDER	E27 or E26 *
MAX WATTAGE	6.5W x 1
VOLTAGE	220/240v or 110/120v *
IP RATING	65
CLASS PROTECTION	II
SHADE CODE	GL089 GLWP02
CABLE CHAIN BAR LENGT	n/a
CABLE TYPE	-

Fixing Bracket MLWB17 | Matt Black

* Fixing bracket may differ for UL wired products.

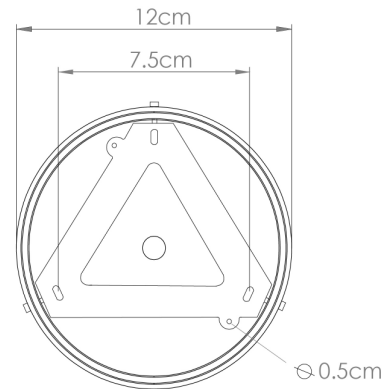

Product Notes:

1) Bulbs not included. 2) Dimensions do not include bulbs. 3) All products are individually made-to-order and therefore may differ slightly within manufacturing tolerances. 4) Cable / chain can be shortened during installation. Longer cable / chain lengths available on request. 5) Additional colour finishes may be available on request. 6) UL wired products operate at 110/120v with the appropriate lamp holder. 7) Twisted cable is not available for UL wired products. Round cable in black or brown only is supplied instead. 8) Refer to our website for a full list of terms and conditions.

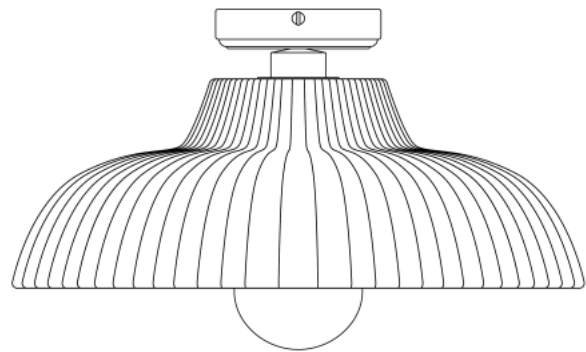

MATERIAL	Brass Glass
HEIGHT	25cm 9.84"
WIDTH DIAMETER	40cm 15.75"
LENGTH PROJECTION	n/a
WEIGHT	3.12KG 6.88lbs
LAMP HOLDER	E27 or E26 *
MAX WATTAGE	6.5W x 1
VOLTAGE	220/240v or 110/120v *
IP RATING	65
CLASS PROTECTION	II
SHADE CODE	GL089 GLWP01
CABLE CHAIN BAR LENGT	n/a
CABLE TYPE	-

Fixing Bracket MLWB17 | White

* Fixing bracket may differ for UL wired products.

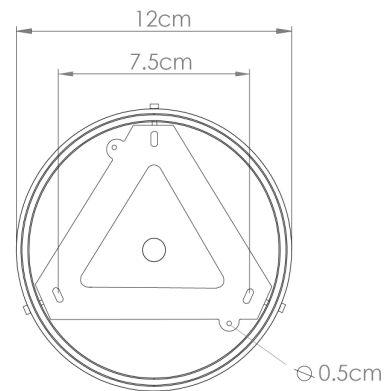

Product Notes:

1) Bulbs not included. 2) Dimensions do not include bulbs. 3) All products are individually made-to-order and therefore may differ slightly within manufacturing tolerances. 4) Cable / chain can be shortened during installation. Longer cable / chain lengths available on request. 5) Additional colour finishes may be available on request. 6) UL wired products operate at 110/120v with the appropriate lamp holder. 7) Twisted cable is not available for UL wired products. Round cable in black or brown only is supplied instead. 8) Refer to our website for a full list of terms and conditions.

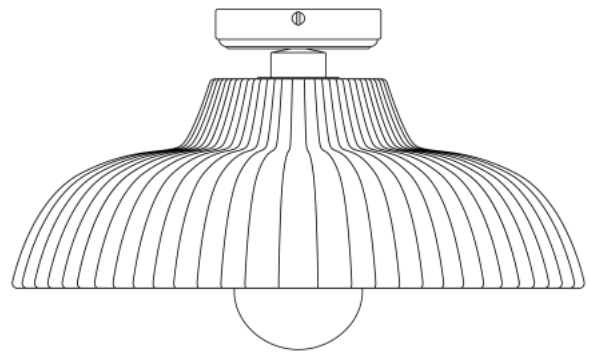

MATERIAL	Brass Glass
HEIGHT	25cm 9.84"
WIDTH DIAMETER	40cm 15.75"
LENGTH PROJECTION	n/a
WEIGHT	3.12KG 6.88lbs
LAMP HOLDER	E27 or E26 *
MAX WATTAGE	6.5W x 1
VOLTAGE	220/240v or 110/120v *
IP RATING	65
CLASS PROTECTION	II
SHADE CODE	GL089 GLWP02
CABLE CHAIN BAR LENGT	n/a
CABLE TYPE	-

Fixing Bracket MLWB17 | White

* Fixing bracket may differ for UL wired products.

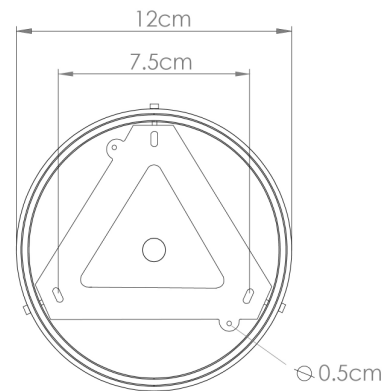

Product Notes:

1) Bulbs not included. 2) Dimensions do not include bulbs. 3) All products are individually made-to-order and therefore may differ slightly within manufacturing tolerances. 4) Cable / chain can be shortened during installation. Longer cable / chain lengths available on request. 5) Additional colour finishes may be available on request. 6) UL wired products operate at 110/120v with the appropriate lamp holder. 7) Twisted cable is not available for UL wired products. Round cable in black or brown only is supplied instead. 8) Refer to our website for a full list of terms and conditions.

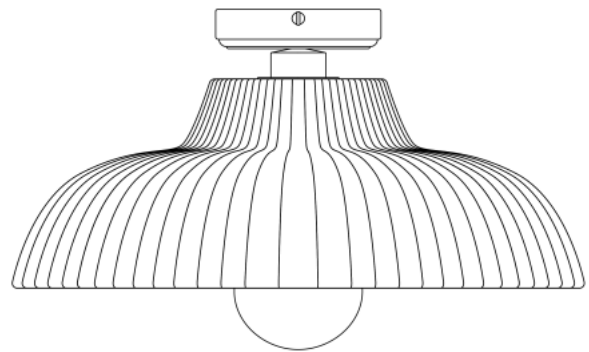

MATERIAL	Brass Glass
HEIGHT	25cm 9.84"
WIDTH DIAMETER	40cm 15.75"
LENGTH PROJECTION	n/a
WEIGHT	3.12KG 6.88lbs
LAMP HOLDER	E27 or E26 *
MAX WATTAGE	6.5W x 1
VOLTAGE	220/240v or 110/120v *
IP RATING	65
CLASS PROTECTION	II
SHADE CODE	GL089 GLWP01
CABLE CHAIN BAR LENGT	n/a
CABLE TYPE	-

Fixing Bracket MLWB17 | Polished Brass

* Fixing bracket may differ for UL wired products.

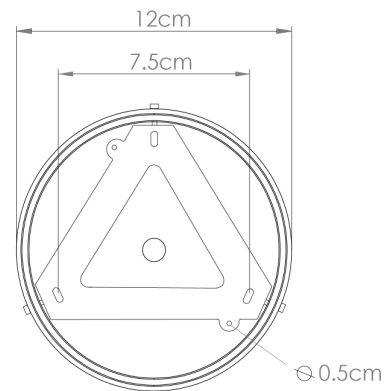

Product Notes:

1) Bulbs not included. 2) Dimensions do not include bulbs. 3) All products are individually made-to-order and therefore may differ slightly within manufacturing tolerances. 4) Cable / chain can be shortened during installation. Longer cable / chain lengths available on request. 5) Additional colour finishes may be available on request. 6) UL wired products operate at 110/120v with the appropriate lamp holder. 7) Twisted cable is not available for UL wired products. Round cable in black or brown only is supplied instead. 8) Refer to our website for a full list of terms and conditions.

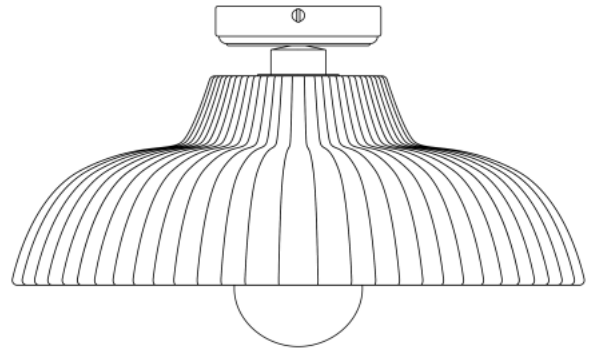

MATERIAL	Brass Glass
HEIGHT	25cm 9.84"
WIDTH DIAMETER	40cm 15.75"
LENGTH PROJECTION	n/a
WEIGHT	3.12KG 6.88lbs
LAMP HOLDER	E27 or E26 *
MAX WATTAGE	6.5W x 1
VOLTAGE	220/240v or 110/120v *
IP RATING	65
CLASS PROTECTION	II
SHADE CODE	GL089 GLWP02
CABLE CHAIN BAR LENGT	n/a
CABLE TYPE	-

Fixing Bracket MLWB17 | Polished Brass

* Fixing bracket may differ for UL wired products.

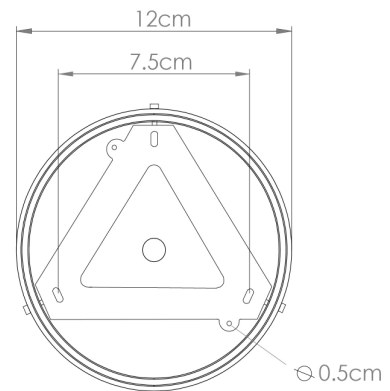

Product Notes:

1) Bulbs not included. 2) Dimensions do not include bulbs. 3) All products are individually made-to-order and therefore may differ slightly within manufacturing tolerances. 4) Cable / chain can be shortened during installation. Longer cable / chain lengths available on request. 5) Additional colour finishes may be available on request. 6) UL wired products operate at 110/120v with the appropriate lamp holder. 7) Twisted cable is not available for UL wired products. Round cable in black or brown only is supplied instead. 8) Refer to our website for a full list of terms and conditions.



SATIN BRASS

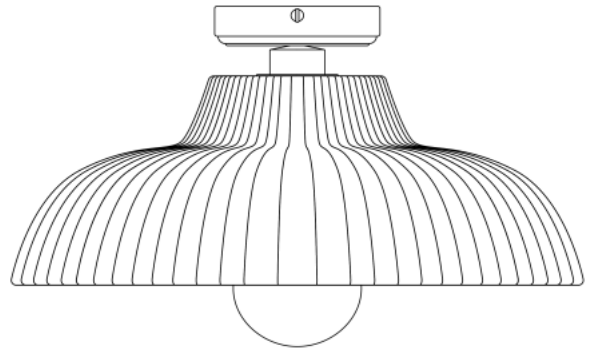

MATERIAL	Brass Glass
HEIGHT	25cm 9.84"
WIDTH DIAMETER	40cm 15.75"
LENGTH PROJECTION	n/a
WEIGHT	3.12KG 6.88lbs
LAMP HOLDER	E27 or E26 *
MAX WATTAGE	6.5W x 1
VOLTAGE	220/240v or 110/120v *
IP RATING	65
CLASS PROTECTION	II
SHADE CODE	GL089 GLWP01
CABLE CHAIN BAR LENGT	n/a
CABLE TYPE	-

Fixing Bracket MLWB17 | Satin Brass

* Fixing bracket may differ for UL wired products.

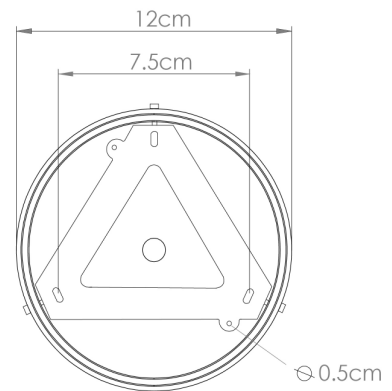

Product Notes:

1) Bulbs not included. 2) Dimensions do not include bulbs. 3) All products are individually made-to-order and therefore may differ slightly within manufacturing tolerances. 4) Cable / chain can be shortened during installation. Longer cable / chain lengths available on request. 5) Additional colour finishes may be available on request. 6) UL wired products operate at 110/120v with the appropriate lamp holder. 7) Twisted cable is not available for UL wired products. Round cable in black or brown only is supplied instead. 8) Refer to our website for a full list of terms and conditions.



SATIN BRASS

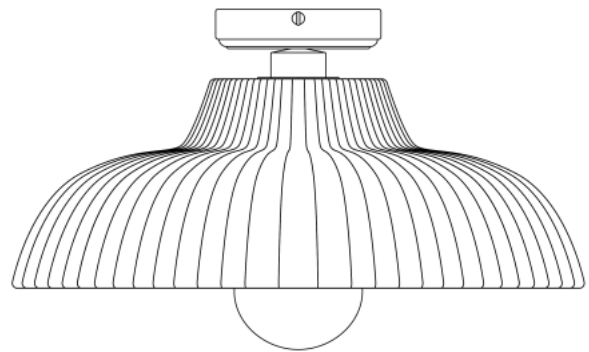

MATERIAL	Brass Glass
HEIGHT	25cm 9.84"
WIDTH DIAMETER	40cm 15.75"
LENGTH PROJECTION	n/a
WEIGHT	3.12KG 6.88lbs
LAMP HOLDER	E27 or E26 *
MAX WATTAGE	6.5W x 1
VOLTAGE	220/240v or 110/120v *
IP RATING	65
CLASS PROTECTION	II
SHADE CODE	GL089 GLWP02
CABLE CHAIN BAR LENGT	n/a
CABLE TYPE	-

Fixing Bracket MLWB17 | Satin Brass

* Fixing bracket may differ for UL wired products.

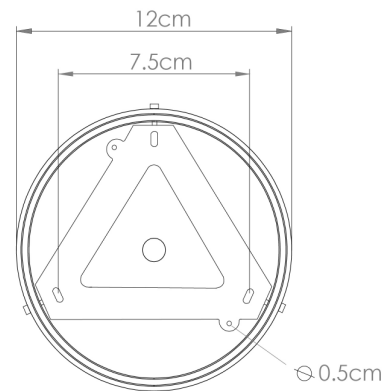

Product Notes:

1) Bulbs not included. 2) Dimensions do not include bulbs. 3) All products are individually made-to-order and therefore may differ slightly within manufacturing tolerances. 4) Cable / chain can be shortened during installation. Longer cable / chain lengths available on request. 5) Additional colour finishes may be available on request. 6) UL wired products operate at 110/120v with the appropriate lamp holder. 7) Twisted cable is not available for UL wired products. Round cable in black or brown only is supplied instead. 8) Refer to our website for a full list of terms and conditions.