

MATERIAL	Brass Glass
HEIGHT	39cm 15.35"
WIDTH DIAMETER	30cm 11.81"
LENGTH PROJECTION	n/a
WEIGHT	1.85KG 4.08lbs
LAMPHOLDER	E27 x 1
MAX WATTAGE	40W x 1
VOLTAGE	220/240v
IP RATING	44
CLASS PROTECTION	II
SHADE	GL136
FLEX BAR CHAIN LENGT	100cm 40"
CABLE TYPE	MLOCA001 2 Core Round Brown Braid Rubber

Fixing Bracket MLROSE31 | Antique Brass

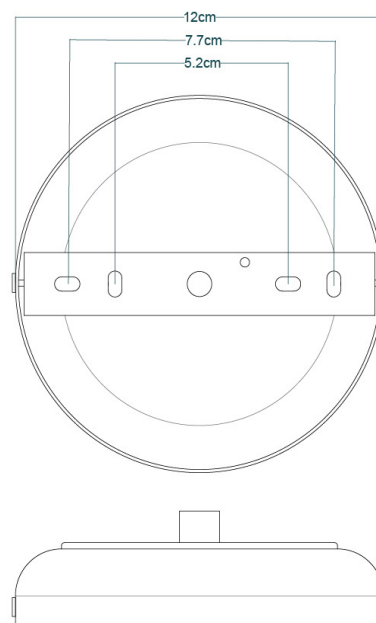

Product Notes:

1) Lamps not included with light fixture. 2) All products are individually hand crafted, therefore may differ slightly within manufacturing tolerances. 3) Please refer to: <http://www.mullanlighting.com/terms> for full list of Terms & Conditions. 4) Cable/Chain can be shortened during installation. 5) Longer Cable/Chain available on request. 6) Additional colour finishes available on request. 7.) Dimensions do not include lamps. 8.) Products wired to UL standards will operate at 110/120v with the appropriate lampholders.

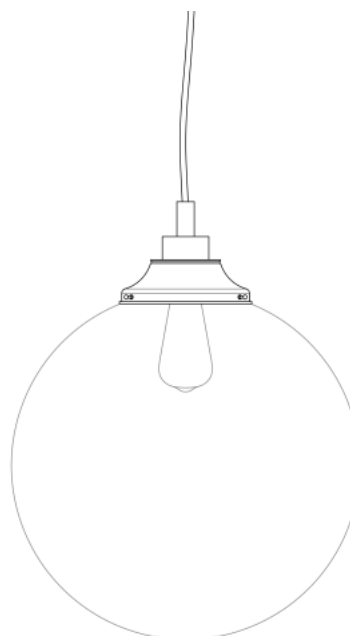

MATERIAL	Brass Glass
HEIGHT	39cm 15.35"
WIDTH DIAMETER	30cm 11.81"
LENGTH PROJECTION	n/a
WEIGHT	1.85KG 4.08lbs
LAMPHOLDER	E27 x 1
MAX WATTAGE	40W x 1
VOLTAGE	220/240v
IP RATING	44
CLASS PROTECTION	II
SHADE	GL136
FLEX BAR CHAIN LENGT	100cm 40"
CABLE TYPE	MLOCA002 2 Core Round Black Braid Rubber

Fixing Bracket MLROSE31 | Antique Silver

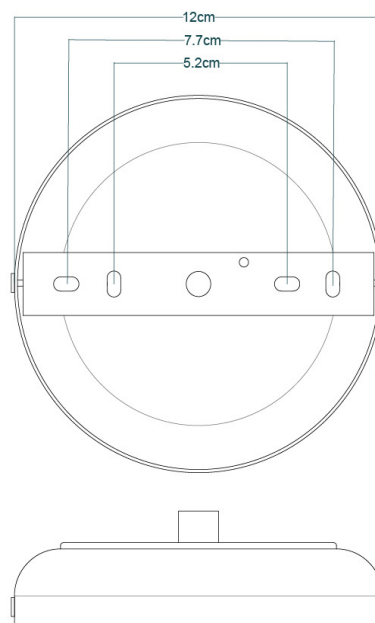

Product Notes:

1) Lamps not included with light fixture. 2) All products are individually hand crafted, therefore may differ slightly within manufacturing tolerances. 3) Please refer to: <http://www.mullanlighting.com/terms> for full list of Terms & Conditions. 4) Cable/Chain can be shortened during installation. 5) Longer Cable/Chain available on request. 6) Additional colour finishes available on request. 7.) Dimensions do not include lamps. 8.) Products wired to UL standards will operate at 110/120v with the appropriate lampholders.

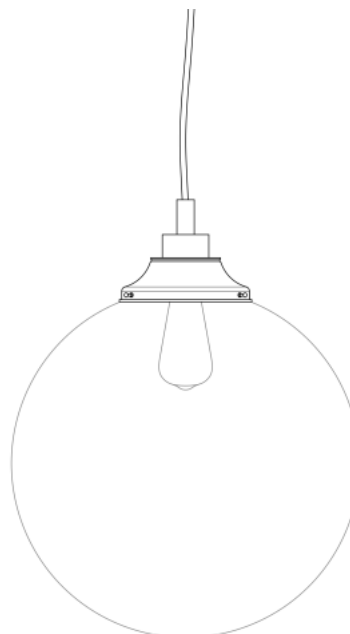

MATERIAL	Brass Glass
HEIGHT	39cm 15.35"
WIDTH DIAMETER	30cm 11.81"
LENGTH PROJECTION	n/a
WEIGHT	1.85KG 4.08lbs
LAMPHOLDER	E27 x 1
MAX WATTAGE	40W x 1
VOLTAGE	220/240v
IP RATING	44
CLASS PROTECTION	II
SHADE	GL136
FLEX BAR CHAIN LENGT	100cm 40"
CABLE TYPE	MLOCA002 2 Core Round Black Braid Rubber

Fixing Bracket MLROSE31 | Natural Brass

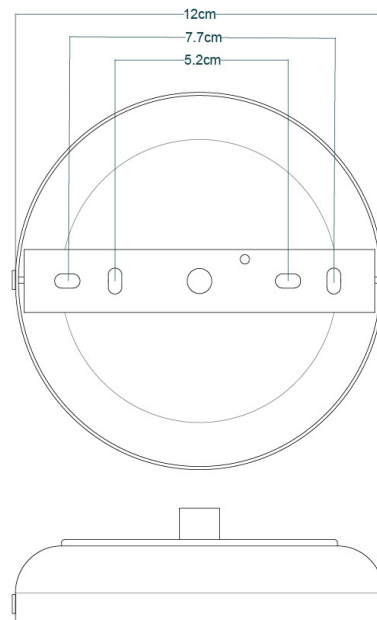

Product Notes:

1) Lamps not included with light fixture. 2) All products are individually hand crafted, therefore may differ slightly within manufacturing tolerances. 3) Please refer to: <http://www.mullanlighting.com/terms> for full list of Terms & Conditions. 4) Cable/Chain can be shortened during installation. 5) Longer Cable/Chain available on request. 6) Additional colour finishes available on request. 7.) Dimensions do not include lamps. 8.) Products wired to UL standards will operate at 110/120v with the appropriate lampholders.

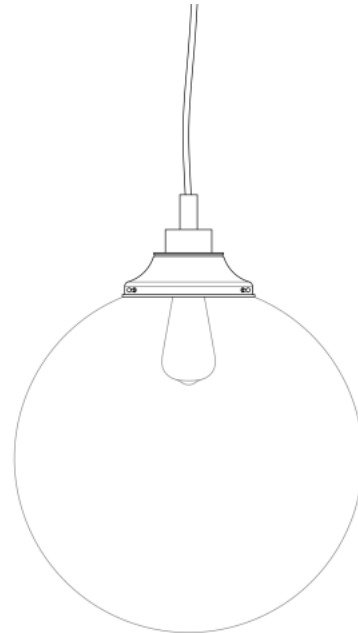

MATERIAL	Brass Glass
HEIGHT	39cm 15.35"
WIDTH DIAMETER	30cm 11.81"
LENGTH PROJECTION	n/a
WEIGHT	1.85KG 4.08lbs
LAMPHOLDER	E27 x 2
MAX WATTAGE	40W x 2
VOLTAGE	220/240v
IP RATING	44
CLASS PROTECTION	II
SHADE	GL136
FLEX BAR CHAIN LENGT	100cm 40"
CABLE TYPE	MLOCA002 2 Core Round Black Braid Rubber

Fixing Bracket MLROSE31 | Matt Black

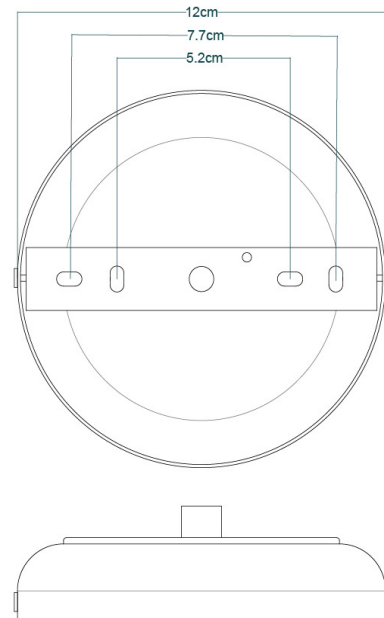

Product Notes:

1) Lamps not included with light fixture. 2) All products are individually hand crafted, therefore may differ slightly within manufacturing tolerances. 3) Please refer to: <http://www.mullanlighting.com/terms> for full list of Terms & Conditions. 4) Cable/Chain can be shortened during installation. 5) Longer Cable/Chain available on request. 6) Additional colour finishes available on request. 7.) Dimensions do not include lamps. 8.) Products wired to UL standards will operate at 110/120v with the appropriate lampholders.

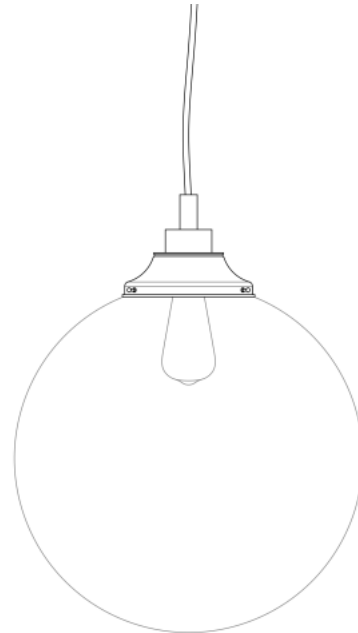

MATERIAL	Brass Glass
HEIGHT	39cm 15.35"
WIDTH DIAMETER	30cm 11.81"
LENGTH PROJECTION	n/a
WEIGHT	1.85KG 4.08lbs
LAMPHOLDER	E27 x 1
MAX WATTAGE	40W x 1
VOLTAGE	220/240v
IP RATING	44
CLASS PROTECTION	II
SHADE	GL136
FLEX BAR CHAIN LENGT	100cm 40"
CABLE TYPE	MLOCA002 2 Core Round Black Braid Rubber

Fixing Bracket MLROSE31 | White

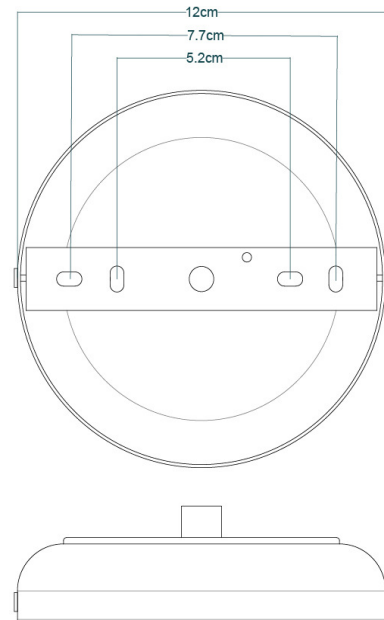

Product Notes:

1) Lamps not included with light fixture. 2) All products are individually hand crafted, therefore may differ slightly within manufacturing tolerances. 3) Please refer to: <http://www.mullanlighting.com/terms> for full list of Terms & Conditions. 4) Cable/Chain can be shortened during installation. 5) Longer Cable/Chain available on request. 6) Additional colour finishes available on request. 7.) Dimensions do not include lamps. 8.) Products wired to UL standards will operate at 110/120v with the appropriate lampholders.

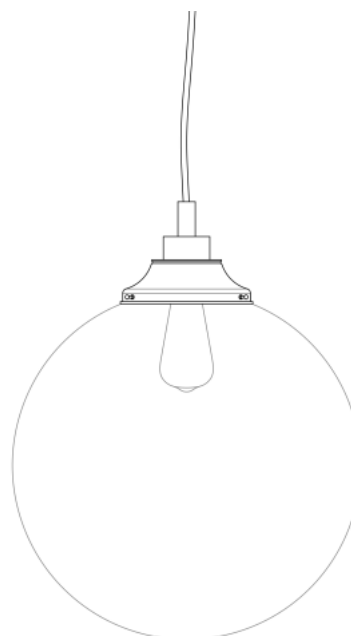

MATERIAL	Brass Glass
HEIGHT	39cm 15.35"
WIDTH DIAMETER	30cm 11.81"
LENGTH PROJECTION	n/a
WEIGHT	1.85KG 4.08lbs
LAMPHOLDER	E27 x 1
MAX WATTAGE	40W x 1
VOLTAGE	220/240v
IP RATING	44
CLASS PROTECTION	II
SHADE	GL136
FLEX BAR CHAIN LENGT	100cm 40"
CABLE TYPE	MLOCA002 2 Core Round Black Braid Rubber

Fixing Bracket MLROSE31 | Polished Brass

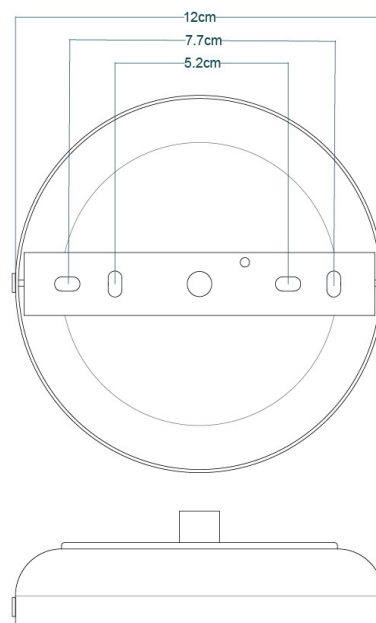

Product Notes:

1) Lamps not included with light fixture. 2) All products are individually hand crafted, therefore may differ slightly within manufacturing tolerances. 3) Please refer to: <http://www.mullanlighting.com/terms> for full list of Terms & Conditions. 4) Cable/Chain can be shortened during installation. 5) Longer Cable/Chain available on request. 6) Additional colour finishes available on request. 7.) Dimensions do not include lamps. 8.) Products wired to UL standards will operate at 110/120v with the appropriate lampholders.

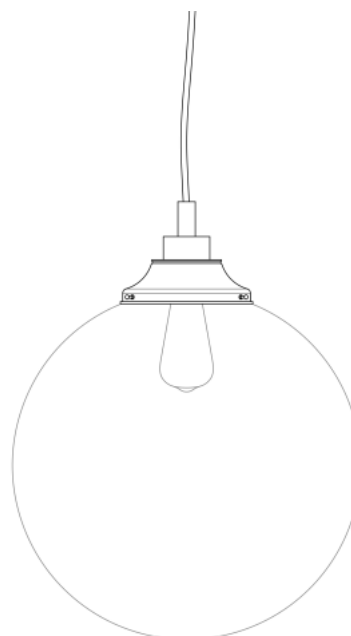

MATERIAL	Brass Glass
HEIGHT	39cm 15.35"
WIDTH DIAMETER	30cm 11.81"
LENGTH PROJECTION	n/a
WEIGHT	1.85KG 4.08lbs
LAMPHOLDER	E27 x 1
MAX WATTAGE	40W x 1
VOLTAGE	220/240v
IP RATING	44
CLASS PROTECTION	II
SHADE	GL136
FLEX BAR CHAIN LENGT	100cm 40"
CABLE TYPE	MLOCA002 2 Core Round Black Braid Rubber

Fixing Bracket MLROSE31 | Satin Brass

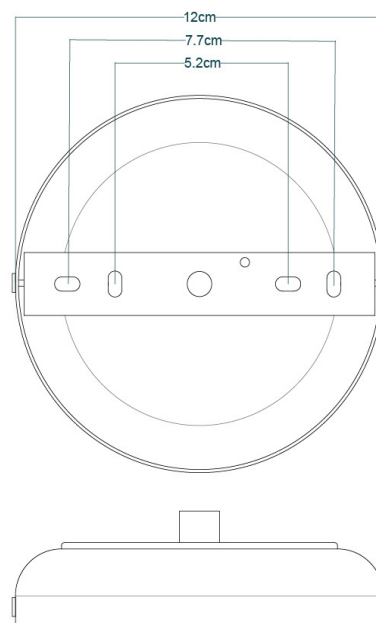

Product Notes:

1) Lamps not included with light fixture. 2) All products are individually hand crafted, therefore may differ slightly within manufacturing tolerances. 3) Please refer to: <http://www.mullanlighting.com/terms> for full list of Terms & Conditions. 4) Cable/Chain can be shortened during installation. 5) Longer Cable/Chain available on request. 6) Additional colour finishes available on request. 7.) Dimensions do not include lamps. 8.) Products wired to UL standards will operate at 110/120v with the appropriate lampholders.